

# 2019

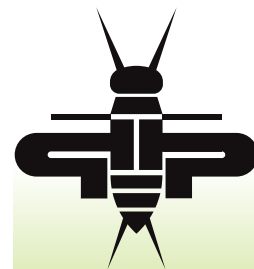

# Grillo

AGRIGARDEN  
MACHINES



**MD 28 AWD**



**GH 9**



# G Z1 - G Z2







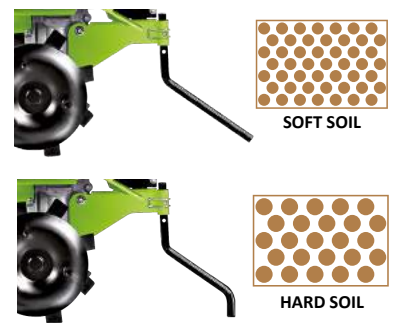
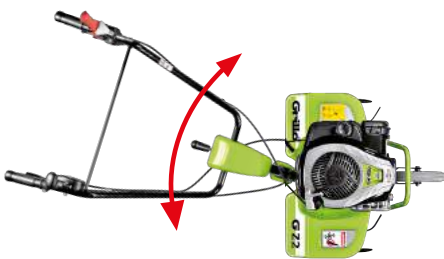

G Z1



G Z2



		<b>HP-kW</b>		 L (US qts)						 kg (lb)
<b>G Z1</b>	575 EX B&S	HP 3 - kW 2.2	140/1	 0,8 (0.84)		<b>GEAR TRANSMISSION</b> 155 rpm	--	 A 28 cm (11 in)	 52 cm (20 in)	35 (77)
<b>G Z2</b>	575 EX B&S	HP 3 - kW 2.2	140/1	 0,8 (0.84)		<b>GEAR TRANSMISSION</b> 155 rpm	Max 2,1 km/h (1.3 mph)	 A 28 cm (11 in)	 52 cm (20 in)	41 (90)

# G Z3

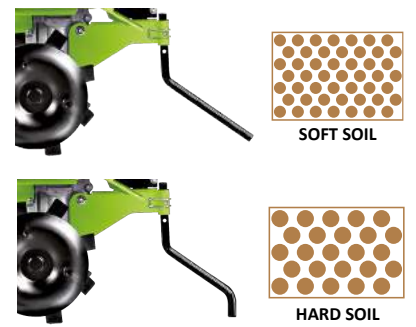

		HP-kW	CC	L (US qts)		GEAR TRANSMISSION				kg (lb)
<b>G Z3</b>	GCV 160 Honda	HP 4.4 - kW 3.3	160/1	0,9 (0.95)		155 rpm	Max 2,1 km/h (1.3 mph)	A 28 cm (11 in)	75 cm (29.5 in)	45 (99)



PRINCESS MR

# PRINCESS







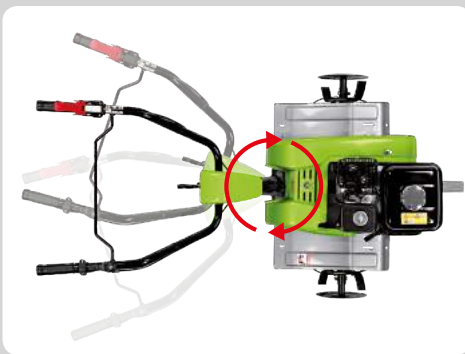



## M1 - MR



PRINCESS M1



PRINCESS MR

		<b>HP-kW</b>		 L (US qts)						 kg (lb)
<b>M1</b>	3000 Kohler	HP 5.5 - kW 4.1	196/1	3,6 (3.8)		① 132 rpm	--	A 32 cm (12 in)	30-52-77 cm (12-20-30 in)	62 (137)
	GX 160 Honda	HP 4.8 - kW 3.6	163/1	3,1 (3.3)		59 (130)				
<b>MR</b>	3000 Kohler	HP 5.5 - kW 4.1	196/1	3,6 (3.8)		① 132 rpm	Max 2,3 km/h (1.4 mph)	A 32 cm (12 in)	30-52-77 cm (12-20-30 in)	64 (141)
	GX 160 Honda	HP 4.8 - kW 3.6	163/1	3,1 (3.3)						61 (134)



# PRINCESS

## MP3



		HP-kW	CC/	L (US qts)					kg (lb)
MP3	3000 Kohler	HP 5.5 - kW 4.1	196/1	3,6 (3.8)		GEAR TRANSMISSION			65 (143)
	GX 160 Honda	HP 4.8 - kW 3.6	163/1	3,1 (3.3)		① 36 rpm ② 160 rpm	Max 2,3 km/h (1.4 mph)	A 32 cm (12 in)	30-52-77 cm (12-20-30 in)



PRINCESS MP3 PRO

# PRINCESS MP3 PRO

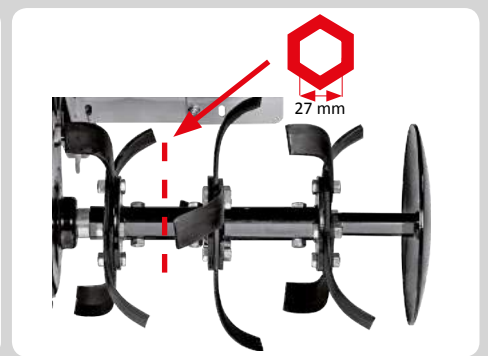

		HP-kW	CC	 L (US qts)		GEAR TRANSMISSION				 kg (lb)
<b>MP3 PRO</b>	GX 200 Honda	HP 5.5 - kW 4.1	196/1	3,1 (3.3)		① 36 rpm ② 160 rpm	Max 2,3 km/h (1.4 mph)	A 33 cm (13 in)	56-82 cm (22-32 in)	66 (145)

# 2500 - 3500



2500





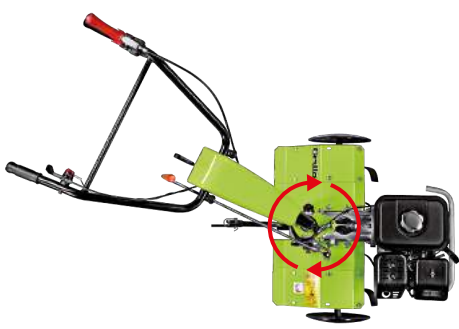





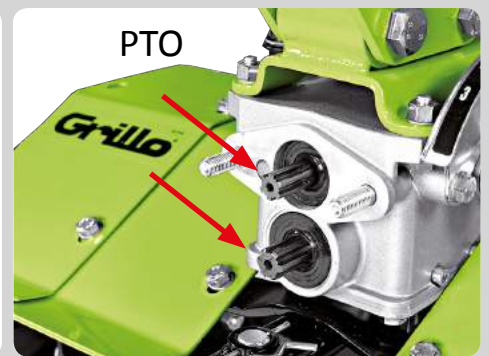
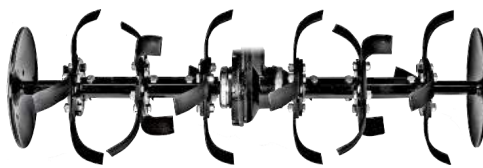
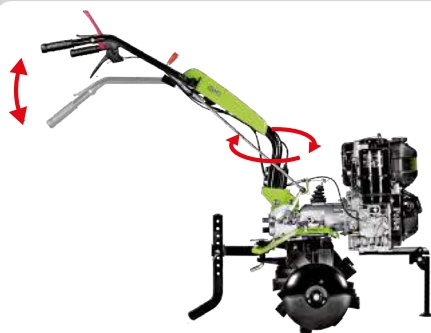



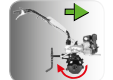

3500



		HP-kW	CC	 L (US qts)						 kg (lb)
2500	3000 Kohler	HP 5.5 - kW 4.1	196/1	3,6 (3.8)		GEAR TRANSMISSION ① 53 rpm ② 123 rpm		A 32 cm (12 in)	58-85 cm (23-33 in)	75 (165)
	EX 17	HP 5 - kW 3.7	169/1	3,6 (3.8)						74 (163)
	GX 160 Honda	HP 4.8 - kW 3.6	163/1	3,1 (3.3)						72 (159)
3500	3000 Kohler	HP 5.5 - kW 4.1	196/1	3,6 (3.8)		GEAR TRANSMISSION ① 53 rpm ② 123 rpm		A 32 cm (12 in)	58-85-111 cm (23-33-43 in)	81 (179)
	EX 17	HP 5 - kW 3.7	169/1	3,6 (3.8)						80 (176)
	GX 160 Honda	HP 4.8 - kW 3.6	163/1	3,1 (3.3)						78 (172)

# 11500



		HP-kW	CC 	 L (US qts)						 kg (lb)
<b>11500</b>	EX 27	HP 8.3 - kW 6.1	265/1	 6,1 (6.4)		<b>GEAR TRANSMISSION</b>				90 (198)
	15 LD 350 Lombardini	HP 7.5 - kW 5.5	349/1	Diesel  4,3 (4.5)		① 53 rpm ② 123 rpm ③ 162 rpm	Max 3 km/h (1.8 mph)	A 33 cm (13 in)	59-86-112 cm (23-34-44 in)	110 (242)
	15 LD 350 Lombardini	HP 7.5 - kW 5.5	349/1	Diesel  4,3 (4.5)						121 (267)



# G 45

## CONTRA-ROTATING TILLER

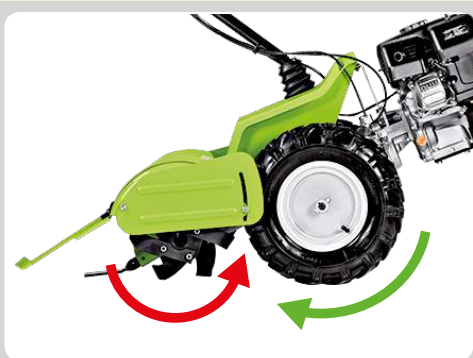









										
	HP-kW	CC	L (US qts)		GEAR TRANSMISSION					kg (lb)
<b>G 45</b>	3000 Kohler	HP 5.5 - kW 4.1	196/1	3,6 (3.8)		 <b>4.00-8</b> 1,6 km/h (1 mph) 	 <b>4.00-8</b> 2,5 km/h (1.5 mph) 	<b>A</b> 26 cm (10 in)	50 cm (20 in)	82 (181)

# G 46







## CONTRA-ROTATING TILLER



										
		HP-kW	CC	L (US qts)		GEAR TRANSMISSION		A		kg (lb)
<b>G 46</b>	GX 200 Honda	HP 5.5 - kW 4.1	196/1	3,1 (3.3)		 1,6 km/h (1 mph) 	 1,6 km/h (1 mph) 	A 26 cm (10 in)	50 cm (20 in)	98 (216)

# G 52



										
<b>G 52</b>	3000 Kohler	HP 5.5 - kW 4.1	196/1	3,6 (3.8)		<b>GEAR TRANSMISSION</b>  13x5.00-6  13x5.00-6 1,4 km/h (0.9 mph)    2,2 km/h (1.4 mph)   2,2 km/h (1.4 mph)    1,4 km/h (0.9 mph)  		A 26 cm (10 in)	37-50 cm (15-20 in)	67 (148)

# G 55



LABOUR KIT











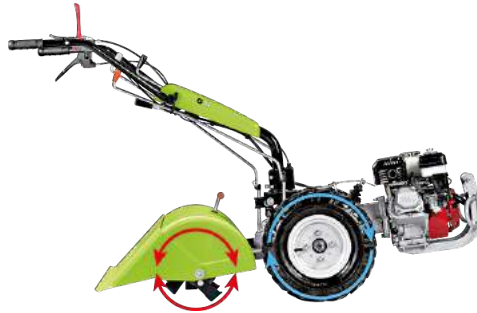







		HP-kW	CC	 L (US qts)						 kg (lb)
<b>G 55</b>	EX 17	HP 5 - kW 3.7	169/1	3,6 (3.8)		<b>GEAR TRANSMISSION</b> <b>4.00-8</b> I 1,1 km/h (0.7 mph) II 2,6 km/h (1.6 mph)		A 26 cm (10 in)	37-50-58 cm (15-20-23 in)	86 (189)
	GX 160 Honda	HP 4.8 - kW 3.6	163/1	3,1 (3.3)		<b>4.00-8</b> I 1,1 km/h (0.7 mph) II 2,6 km/h (1.6 mph)				86 (189)

# G 84



## FORWARD AND CONTRA-ROTATING TILLER



		HP-kW	CC/ 	 DIESEL L (US qts)						 kg (lb)
<b>G 84</b>	GX 200 Honda	HP 5.5 - kW 4.1	196/1	<b>3,1 (3.3)</b>		<b>GEAR TRANSMISSION</b>  <b>4.00-8</b> 1,1 km/h (0.7 mph) 2,6 km/h (1.6 mph)  1,1 km/h (0.7 mph) 2,6 km/h (1.6 mph) 	 <b>4.00-8</b> 1,1 km/h (0.7 mph) 2,6 km/h (1.6 mph)  1,1 km/h (0.7 mph) 2,6 km/h (1.6 mph) 	<b>A</b> 32 cm (12 in)	37-47-58 cm (15-19-23 in)	105 (230)

# G 85d























## FORWARD AND CONTRA-ROTATING TILLER



		HP-kW	CC	 L (US qts)		 DIFF. LOCK				 kg (lb)
<b>G 85d</b>	EX 27	HP 8.3 - kW 6.1	265/1	 6,1 (6.4)		✓	<b>GEAR TRANSMISSION</b> 4.00-8	4.00-8		113 (249)
	15 LD 350 Lombardini	HP 7.5 - kW 5.5	349/1	 4,3 (4.5)		✓	⓪ 1,1 km/h (0.7 mph)	⓪ 1,1 km/h (0.7 mph)		127 (280)
	EX 27	HP 8.3 - kW 6.1	265/1	 6,1 (6.4)		✓	Ⓜ 2,6 km/h (1.6 mph)	Ⓜ 2,6 km/h (1.6 mph)	A 32 cm (12 in)	125 (275)
	15 LD 350 Lombardini	HP 7.5 - kW 5.5	349/1	 4,3 (4.5)		✓	⓪ 1,1 km/h (0.7 mph)	⓪ 1,1 km/h (0.7 mph)	37-47-58-68- 77 cm (15-19-23-27- 30 in)	144 (317)

# G 107d



		HP-kW	CC	 L (US qts)		 DIFF. LOCK					 kg (lb)
<b>G 107d</b>	EX 27	HP 8.3 - kW 6.1	265/1	 6,1 (6.4)		✓	<b>GEAR TRANSMISSION</b>  <b>4.00-10</b> ① 1,2 km/h (0.7 mph) ② 2,2 km/h (1.4 mph) ③ 3,3 km/h (2.1 mph) →	 <b>4.00-10</b> ① 1,2 km/h (0.7 mph) ② 2,2 km/h (1.4 mph) ③ 3,3 km/h (2.1 mph) →	A 32 cm (12 in)	37-47-58-68-77 cm (15-19-23-27-30 in)	122 (269)
	15 LD 440 Lombardini	HP 11 - kW 8.1	441/1	 Diesel  5 (5.3)		✓	① 1,2 km/h (0.7 mph) ② 2,2 km/h (1.4 mph) ③ 3,3 km/h (2.1 mph) →	① 1,2 km/h (0.7 mph) ② 2,2 km/h (1.4 mph) ③ 3,3 km/h (2.1 mph) →			148 (326)
	EX 27	HP 8.3 - kW 6.1	265/1	 6,1 (6.4)		✓	① 1,2 km/h (0.7 mph) ② 2,2 km/h (1.4 mph) ③ 3,3 km/h (2.1 mph) →	① 1,2 km/h (0.7 mph) ② 2,2 km/h (1.4 mph) ③ 3,3 km/h (2.1 mph) →			137 (302)
	15 LD 440 Lombardini	HP 11 - kW 8.1	441/1	 Diesel  5 (5.3)		✓	① 1,2 km/h (0.7 mph) ② 2,2 km/h (1.4 mph) ③ 3,3 km/h (2.1 mph) ←	① 1,2 km/h (0.7 mph) ② 2,2 km/h (1.4 mph) ③ 3,3 km/h (2.1 mph) ←			162 (357)

# G 108 - G 110







































G 108



G 110



























		 CC/HP HP-kW	 DIESEL L (US qts)		 Steering Brakes	 DIFF. LOCK					 kg (lb)	
<b>G 108</b>	GX 270 Honda	270 cc/1 HP 8.4 - kW 6.3	 5,3 (5.6)		✓	✓	<b>GEAR TRANSMISSION</b>  <b>5.00-10</b>  1,3 km/h (0.8 mph)  2,4 km/h (1.5 mph)  4,3 km/h (2.7 mph)		 <b>5.00-10</b>  1,3 km/h (0.8 mph)  2,4 km/h (1.5 mph)  4,3 km/h (2.7 mph)			132 (291)
<b>G 110</b>	GX 390 Honda	389 cc/1 HP 11.7 - kW 8.7	 6,1 (6.4)		✓	✓	 0.7 km/h (0.4 mph)  1.5 km/h (0.9 mph)  3.2 km/h (2.0 mph)		 0.7 km/h (0.4 mph)  1.5 km/h (0.9 mph)  3.2 km/h (2.0 mph)		<b>A 32 cm (12.6 in)</b> 37-47-58-68-77 cm (15-19-23-27-30 in)	138 (304)
	15 LD 440 Lombardini	441 cc/1 HP 11 - kW 8.1	 Diesel 5 (5.3)		✓	✓	 0.7 km/h (0.4 mph)  1.5 km/h (0.9 mph)  3.2 km/h (2.0 mph)		 0.7 km/h (0.4 mph)  1.5 km/h (0.9 mph)  3.2 km/h (2.0 mph)			164 (361)











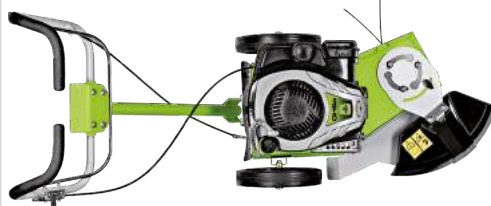



# G 131



		HP-kW	CC 	 L (US qts)		 DIFF. LOCK						 kg (lb)
<b>G 131</b>	3 LD 510 Lombardini	HP 12.2 - kW 9	510/1	Diesel 5,3 (5.6)			<b>GEAR TRANSMISSION</b>  <b>5.00-12</b>  1,2 km/h (0.7 mph)  2,4 km/h (1.5 mph)  3,4 km/h (2.1 mph)  7.1 km/h (4.4 mph)  1.7 km/h (1.0 mph)  3.5 km/h (2.2 mph)		 <b>5.00-12</b>  1.7 km/h (1.0 mph)  3.5 km/h (2.2 mph)  2.2 km/h (1.5 mph)	A 32 cm (12.6 in)	55-70-85 cm (22-28-34 in)	215 (474)

# X TRIMMER



										
	HP-kW	CC	L (US qts)							kg (lb)
<b>X TRIMMER</b>	575 EX B&S HP 3 - kW 2.2	140/1	0,8 (0.84)		--	25 cm (9.8 in)	45 - 57 mm (1.8 - 2.2 in)	45 cm (17.7 in)	30 (66)	

# HWT 550 Tilt

# HWT 600 WD



HWT 600 WD



HWT 600 WD

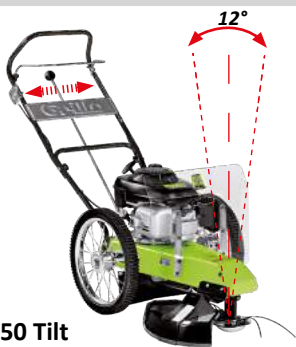



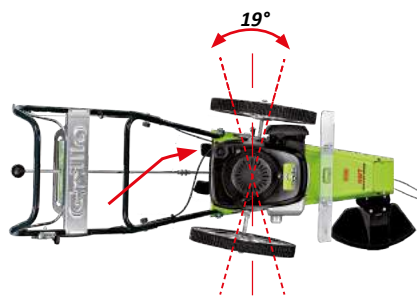







HWT 550 Tilt



HWT 550 Tilt







										
<b>HWT 550 Tilt</b>	GCV 160 Honda	HP 4.4 - kW 3.3	160/1	0,9 (1)		--	41 cm (16.2 in)	10-25-45-57 mm (0.4-1-1.8-2.2 in)	60 cm (24 in)	40 (88)
<b>HWT 600 WD</b>	GCV 160 Honda	HP 4.4 - kW 3.3	160/1	0,9 (1)		<b>GEAR TRANSMISSION</b> 3 km/h (1.9 mph)	41 cm (16.2 in)	10-25-45-57 mm (0.4-1-1.8-2.2 in)	60 cm (24 in)	44 (97)

# HWT 700









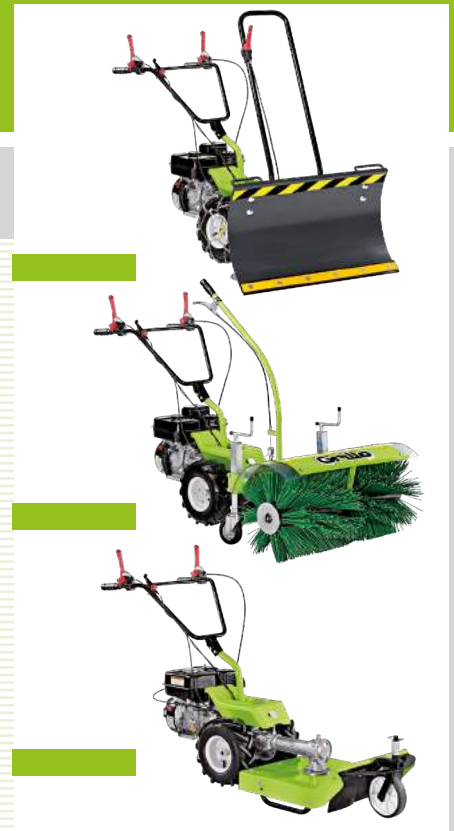



## SUPERTRAC



										
<b>HWT 700 SUPERTRAC</b>	<i>Kawasaki</i> FJ180V KAI	HP 4.5 - kW 3.3	179/1	1.7 (1.5)		<b>GEAR TRANSMISSION</b>  2 km/h (1.2 mph)	3.50-8  38 cm (14.9 in)	15-30-50-60 mm (0.6-1.2-2-2.4 in)	60 cm (24 in)	55 (121)















# GF 1



										
GF 1	3000 Kohler	HP 5.5 - kW 4.1	196/1	3,6 (3.8)		13x5.00-6	<b>GEAR TRANSMISSION</b> 2,20 km/h (1.4 mph)	--	86-96 cm (34-38 in)	67 (148)
	EX 17	HP 5 - kW 3.7	169/1	3,6 (3.8)		13x5.00-6	2,20 km/h (1.4 mph)	--	86-96 cm (34-38 in)	66 (146)

# GF 2











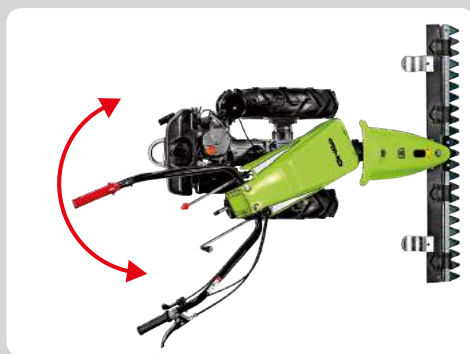



















										
	EX 17	HP 5 - kW 3.7	169/1	3,6 (3.8)			GEAR TRANSMISSION		110-115-117 cm (43-45-46 in)	95 (209)
GF 2	GX 160 Honda	HP 4.8 - kW 3.6	163/1	3,1 (3.3)			 4.00-8 I 1,0 km/h (0.6 mph) II 2,0 km/h (1.2 mph) III 3,0 km/h (1.9 mph)	 4.00-8 I 1,0 km/h (0.6 mph) II 2,0 km/h (1.2 mph) III 3,0 km/h (1.9 mph)		95 (209)

# GF 3 - GF 3DF



GF 3DF



		HP-kW	CC 	 L (US qts)		 Steering Brakes	 DIFF. LOCK					 kg (lb)
GF 3	EX 27	HP 8.3 - kW 6.1	265/1	 6,1 (6.4)		-	-	<b>GEAR TRANSMISSION</b>		 5.00-10	 5.00-10	115 (254)
	15 LD 350 Lombardini	HP 7.5 - kW 5.5	349/1	 4,3 (4.5)		-	-	 I	 I	1,3 km/h (0.8 mph)	1,3 km/h (0.8 mph)	110-115-117 127-135 cm (43-45-46-50-53 in)
GF 3DF	EX 27	HP 8.3 - kW 6.1	265/1	 6,1 (6.4)		✓	✓	 II	 II	2,4 km/h (1.5 mph)	2,4 km/h (1.5 mph)	
	15 LD 350 Lombardini	HP 7.5 - kW 5.5	349/1	 4,3 (4.5)		✓	✓	 III	 III	3,6 km/h (2.2 mph)	3,6 km/h (2.2 mph)	134 (295)

# DUMPER 406

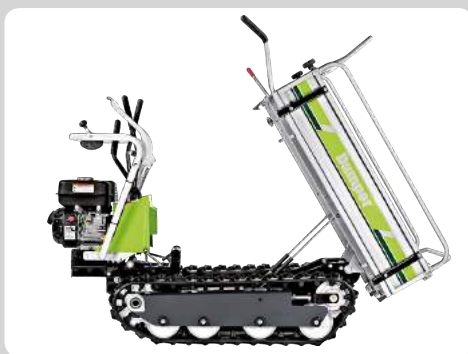

















									
<b>Dumper 406</b>	3000 Kohler	HP 5.5 - kW 4.1	196/1			<b>GEAR TRANSMISSION</b>		400 kg (882 lb)	241 (531)
	GX 200 Honda	HP 5.5 - kW 4.1	196/1			I 1,0 km/h (0.6 mph) II 2,0 km/h (1.2 mph) III 3,5 km/h (2.2 mph)	I 1,0 km/h (0.6 mph) II 2,0 km/h (1.2 mph) III 3,5 km/h (2.2 mph)		242 (533)



# DUMPER 507













									
<b>Dumper 507</b>	EX 27	HP 8.3 - kW 6.1	265/1	 6,1 (6.4)		<b>GEAR TRANSMISSION</b>		500 kg (1102 lb)	276 (608)
	EX 27	HP 8.3 - kW 6.1	265/1	 6,1 (6.4)		① 1,0 km/h (0.6 mph) ② 2,0 km/h (1.2 mph)	① 1,0 km/h (0.6 mph) ② 2,0 km/h (1.2 mph)		288 (635)
	15 LD 350 Lombardini	HP 7.5 - kW 5.5	349/1	Diesel  4,3 (4.5)		③ 3,5 km/h (2.2 mph) ④ 8,7 km/h (5.4 mph)	③ 3,5 km/h (2.2 mph)		286 (631)
	15 LD 350 Lombardini	HP 7.5 - kW 5.5	349/1	Diesel  4,3 (4.5)					311 (686)

# GH 7 - GH 9









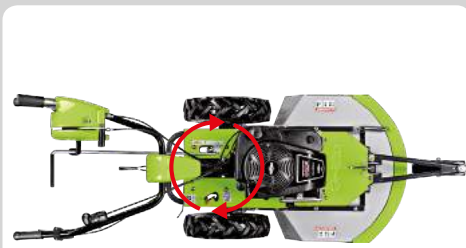



GH 9

		HP-kW		 L (US qts)						 kg (lb)		
<b>GH 7</b>	GX 200 Honda	HP 5.5- kW 4.1	196/1	3,1 (3.3)		<b>HYDROSTATIC</b>		0 - 6 km/h (0 - 3.7 mph)	0 - 3 km/h (0 - 1.9 mph)	30...110 mm (1.2...4.3 in)	68 cm (26.8 in)	150 (331)
<b>GH 9</b>	GX 270 Honda	HP 8.4- kW 6.3	270/1	5,3 (5.6)		<b>HYDROSTATIC</b>		0 - 6 km/h (0 - 3.7 mph)	0 - 3 km/h (0 - 1.9 mph)	30...110 mm (1.2...4.3 in)	68 cm (26.8 in)	162 (357)











# CL 62



										
<b>CL 62</b>	INTEK 950E Series B&S	HP 5.6 - kW 4.2	223/1	1,1 (1.2)		<b>HYDROSTATIC</b>		50...110 mm (2.0...4.3 in)	62 cm (24.4 in)	99 (218)
						0 - 6 km/h (0 - 3.7 mph)	0 - 3,5 km/h (0 - 2.2 mph)			









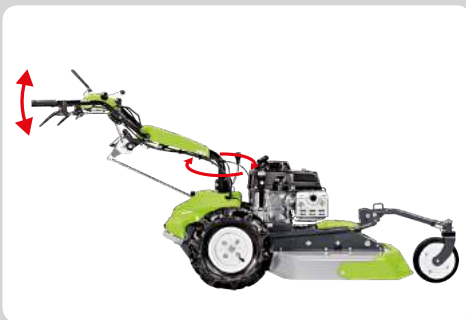

# CL 62M



		HP-kW	 CC	 L (US qts)						 kg (lb)		
<b>CL 62M</b>	KAWASAKI FJ180V	HP 4.5 - kW 3.4	179/1	 1,6 (1.5)		<b>HYDROSTATIC</b>		0 - 4,7 km/h (0 - 2.9 mph)	0 - 3 km/h (0 - 1.9 mph)	50...110 mm (2.0...4.3 in)	62 cm (24.4 in)	98 (216)

# CL 75



		HP-kW											
<b>CL 75</b>	GXV 340 Honda	HP 8.9 - kW 6.6	337/1			✓	<b>HYDROSTATIC</b>		0 - 6 km/h (0 - 3.7 mph)	0 - 3,5 km/h (0 - 2.2 mph)	50...150 mm (2.0...5.9 in)	75 cm (29.5 in)	140 (309)

# CLIMBER 7

7.13 - 7.18















CLIMBER 7.18



CLIMBER 7.18



		HP-kW		 L (US qts)	 DIFF. LOCK	 HYDROSTATIC				 kg (lb)
<b>7.13</b>	INTEK 3.130 B&S	HP 10 - kW 7.2	344/1	 7 (7.4)		0 - 9 km/h (0 - 5.6 mph)	45 cm (18 in)	35...85 mm (1.3...3.3 in)	85 cm (33.5 in)	225 (496)
<b>7.18</b>	INTEK 7180 B&S	HP 15.2 - kW 11.2	656/2	 7 (7.4)		0 - 9 km/h (0 - 5.6 mph)	45 cm (18 in)	35...85 mm (1.3...3.3 in)	85 cm (33.5 in)	235 (518)











# CLIMBER 8

## 8.22



KIT MULCHING













		HP-kW		 L (US qts)						
<b>8.22</b>	7220 Prof. Series B&S	HP18-kW13.2	656/2	 7 (7.4)		HYDROSTATIC	50 cm (19.7 in)	35...110 mm (1.3...4.3 in)	91 cm (36 in)	265 (584)

# CLIMBER 10

## 2WD 27













		HP-kW		 L (US qts)	 DIFF. LOCK	 HYDROSTATIC				 kg (lb)
<b>2WD 27</b>	FS 730V KAWASAKI	HP 22- kW 16.2	726/2	<b>13 (13.7)</b>		0 - 9,5 km/h (0 - 5.9 mph)	65 cm (25.6 in)	35...135 mm (1.4...5.3 in)	98 cm (38,5 in)	375 (827)



# CLIMBER 10

## AWD 22



		HP-kW		 L (US qts)	 DIFF. LOCK	 HYDROSTATIC				 kg (lb)
<b>AWD 22</b>	7220 Prof. Series B&S	HP18-kW13.2	656/2	 13 (13.7)	✓	0 - 9 km/h (0 - 5.6 mph)	70 cm (27.5 in)	35...135 mm (1.4...5.3 in)	93 cm (36.6 in)	345 (761)

# CLIMBER 10









## AWD 27



AWD 27



AWD 27

		HP-kW		 L (US qts)	 DIFF. LOCK	 HYDROSTATIC				 kg (lb)
<b>AWD 27</b>	8270 Commercial Series B&S	HP 22 - kW 16.2	724/2	<b>13 (13.7)</b>	✓	0 - 9 km/h (0 - 5.6 mph)	70 cm (27.5 in)	35...135 mm (1.4...5.3 in)	98 cm (38.6 in)	383 (844)

# MD 13-MD 18



MD 18













MD 18



MD 13









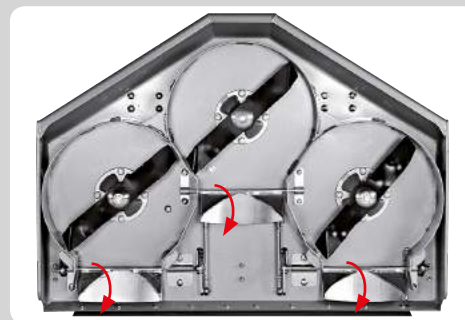

MD 18

		HP-kW		 L (US qts)						 kg (lb)
<b>MD 13</b>	INTEK 3.130 B&S	HP 10 - kW 7.2	344/1		—	HYDROSTATIC 0 - 9 km/h (0 - 5.6 mph)	45 cm (18 in)	25...75 mm (1.0...3.3 in)	QUICK SHIFT 83 cm (32.6 in)	218 (481)
<b>MD 18</b>	INTEK 7180 B&S	HP 15.2 - kW 11.2	656/2		✓	HYDROSTATIC 0 - 9 km/h (0 - 5.6 mph)	45 cm (18 in)	25...80 mm (1.0...3.5 in)	QUICK SHIFT 83 cm (32.6 in)	238 (525)

# MD 22N



		HP-kW		 L (US qts)						
					DIFF. LOCK	HYDROSTATIC			QUICK SHIFT	kg (lb)
<b>MD 22N</b>	7220 Prof. Series B&S	HP 18-kW13.2	656/2	7 (7.4)	✓	0 - 10,5 km/h (0 - 6,5 mph)	48 cm (18.9 in)	25...110 mm (0.9...4.3 in)	110 cm (43 in)	315 (694)

# MD 24 AWD

# MD 28 AWD



MD 28 AWD













MD 24 AWD



MD 28 AWD













										
		HP-kW	CC	L (US qts)	DIFF. LOCK	HYDROSTATIC			QUICK SHIFT	kg (lb)
MD 24 AWD	7220 Prof. Series B&S	HP18-kW13.2	656/2	13 (11.8)	✓	0-9 km/h (0 - 5,6 mph)	70 cm (27.5 in)	25...110 mm (0.9...4.3 in)	110 cm (43 in)	370 (816)
MD 28 AWD	8270 Commercial Series B&S	HP22-kW16.2	724/2	13 (11.8)	✓	0-9 km/h (0 - 5,6 mph)	70 cm (27.5 in)	25...110 mm (0.9...4.3 in)	130 cm (51 in)	383 (844)

# FX 27













## Zero-Turn



										
<b>FX 27</b>	8270 Commercial Series B&S	HP22-kW 16.2	724/2	 30 (7.9) L (US Gal)	0 - 12 km/h (0 - 7.4 mph) <b>HYDROSTATIC</b>	<b>ZERO TURN</b>	30...85 mm (1.2...3.3 in) <b>ELECTRIC</b>	125 cm (49 in)	484 (1067)	<b>H</b> 170 cm <b>D</b> 132 cm <b>W</b> 258 cm













# FD 220R



		HP-kW									
<b>FD 220R</b>	INTEK 3.130 B&S	HP 10 - kW 7.2	344/1	 7 (7.4)	HYDROSTATIC	200 L 5.7 (US bu)	30 cm (11.8 in)	30...90 mm (1.2...3.5 in)	80 cm (31 in)	255 (562)	H 114 cm D 86 cm W 234 cm
	VANGUARD 16 B&S	HP 14 - kW 10.3	479/2	 7 (7.4)	HYDROSTATIC	200 L 5.7 (US bu)	30 cm (11.8 in)	30...90 mm (1.2...3.5 in)	80 cm (31 in)	260 (573)	

# FD 280

















		HP-kW		 L (US qts)								
<b>FD 280</b>	VANGUARD 16 B&S	HP 14 - kW10.3	479/2	 9,5 (10)		0-9,5 km/h (0-5.9 mph)	280 L 8 (US bu)	30 cm (11.8 in)	30...90 mm (1.2...3.5 in)	113 cm (44 in)	320 (705)	H 120 cm D 119 cm W 238 cm



# FD 450















												
	HP-kW	CC	L (US Gal)	DIFF. LOCK		HYDROSTATIC	HYDRAULIC	HYDRAULIC	ELECTRIC		kg (lb)	
<b>FD 450</b>	7220 Prof. Series B&S	HP 18 - kW 13.2	656/2			0 - 11 km/h (0 - 6.8 mph)	450 L 12.8 (US bu)	30 cm (11.8 in)	25...90 mm (1.0...3.5 in)	113 cm (44 in)	440 (970)	H 145 cm D 119 cm W 268 cm

# FD 900

## 4WD













												
		HP-kW	CC	L (US Gal)	DIFF. LOCK	HYDROSTATIC	HYDRAULIC	HYDRAULIC	HYDRAULIC		kg (lb)	H D W
<b>FD 900 4WD</b>	3TNV76 YANMAR	HP 26 - kW 19.2	1116/3	Diesel 31 (8.2)	✓	0 - 14,5 km/h (0 - 9 mph)	750 L 21.3 (US bu)	37 cm (14.6 in)	20...100 mm (0.8...3.9 in)	126 cm (49.6 in)	970 (2138)	H 166 cm D 133 cm W 291 cm

# FD 13.09

## 4WD









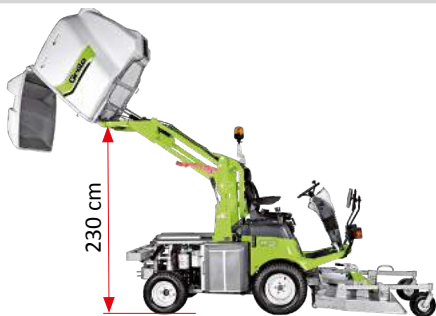



		HP-kW		 L (US Gal)	 DIFF. LOCK	 HYDROSTATIC	 HYDRAULIC	 HYDRAULIC	 HYDRAULIC	 HYDRAULIC	 kg (lb)	 H D W
<b>FD 13.09</b> <b>4WD</b>	3TNV82 YANMAR	HP 31 - kW 22.8	1331/3	Diesel <b>23 (6.0)</b>	✓	0 - 15 km/h (0 - 9.3 mph)	900 L 25.5 (US bu)	31 cm (12 in)	20...100 mm (0.8...3.9 in)	132 cm (52 in)	1230 (2712)	H 175 cm D 141 cm W 325 cm
									20...120 mm (0.8...4.7 in)	155 cm (61 in)		1310 (2888)

# FD 2200

## 4WD













		HP-kW		 L (US Gal)	 DIFF. LOCK	 HYDROSTATIC	 HYDRAULIC	 HYDRAULIC			 kg (lb)	 H D W
<b>FD 2200 4WD</b>	4TNV88 YANMAR	HP44 - kW 33	2190/4	Diesel 50 (13.2)	✓	0 - 20 km/h (0 - 12.4 mph)	1200 L 34 (US bu)	62 cm (24 in)	25...110 mm (0.9...4.3 in)	155 cm (61 in)	1510 (3329)	H 183 cm D 162 cm W 342 cm

# FD 2200 TS

## 4WD













		HP-kW		 L (US Gal)	 DIFF. LOCK	 HYDROSTATIC	 HYDRAULIC	 HYDRAULIC	 HYDRAULIC	 HYDRAULIC	 kg (lb)	
<b>FD 2200</b> TOP SCORER 4WD	4TNV88 YANMAR	HP 48 kW 35.4	2190/4	Diesel 50 (13.2)	✓	0 - 22 km/h (0 - 13.6 mph)	1400 L 39.7 (US bu)	62 cm (24 in)	20...120 mm (0.8...4.7 in)	155 cm (61 in)	1571 (3463)	H 183 cm D 162 cm W 352 cm
										180 cm (71 in)		1620 (3571)

# FM 13.09

## 4WD













		HP-kW		 L (US Gal)	 DIFF. LOCK	 HYDROSTATIC		 HYDRAULIC			 kg (lb)	
<b>FM 13.09</b> <b>4WD</b>	3TNV82 YANMAR	HP31 - kW22.8	1331/3	Diesel <b>23 (6.0)</b>	✓	0 - 15 km/h (0 - 9.3 mph)	12000 m <sup>2</sup> /h	31 cm (12 in)	20...100 mm (0.8...3.9 in)	160 cm (63 in)	1150 (2535)	H 175 cm D 192 cm W 325 cm

# FM 2200

## 4WD



		HP-kW		 L (US Gal)	 DIFF. LOCK	 HYDROSTATIC		 HYDRAULIC			 kg (lb)	
<b>FM 2200</b> <b>4WD</b>	4TNV88 YANMAR	HP 44 - kW 33	2190/4	Diesel <b>50 (13.2)</b>	✓	0 - 20 km/h (0 - 12.4 mph)	15500 m <sup>2</sup> /h	62 cm (24 in)	20...90 mm (0.8...3.5 in)	160 cm (63 in)	1305 (2877)	H 185 cm D 192 cm W 342 cm



Nell'ottica di un costante sviluppo dei propri prodotti, Grillo Spa si riserva il diritto di cambiare le specifiche tecniche e le illustrazioni su questo documento in qualsiasi momento e senza preavviso né obbligo. Foto e caratteristiche non contrattuali. In his pursuing of constant development of his products, Grillo Spa reserves for himself the right to change the technical specifications and the illustrations on this document, at any given moment and without notice and without any kind of obligation. All the pictures characteristics are not contract-binding. En poursuivant une politique constante d'amélioration de ses produits, Grillo Spa se réserve le droit de modifier les spécifications techniques en tout temps sans préavis ni obligation. Photographies et caractéristiques non contractuelles. Aufgrund ständiger Weiterentwicklung behält sich Grillo Spa Änderungen in Form, Technik und Ausstattung der Produktpalette vor. Aus Angaben und Abbildungen des vorliegenden Grillo-Katalogs können daher keine Ansprüche abgeleitet werden. En vista de un desarrollo constante de sus productos, Grillo Spa se reserva el derecho de cambiar las especificaciones técnicas y las ilustraciones mostradas en este documento en cualquier momento y sin aviso previo. Las fotos y características no son contractuales.



**www.grillospa.it**  
 e-mail: grillo@grillospa.it  
 Tel. (0039) 0547.633111  
 Fax (0039) 0547.632011

**www.grillofrance.fr**  
**www.grilloagrigarden.co.uk**  
**www.grillodeutschland.de**  
**www.grilloagrigarden.ru**